

## SaBLE-x™ Bluetooth® Smart (BLE) Module

### FEATURES

- Built in CC2640F128 Bluetooth Smart (BLE 4.1) System-On-Chip (SOC) 5x5mm RHB package with 15 GPIOs
- 128 kB Flash / 20 kB SRAM
- RF Output Power: +5 dBm
- RF Receive Sensitivity: -96 dBm
- Size: 11.6mm x 17.9mm x 2.4mm
- Operating Voltage: 1.8V to 3.8V
- Operating Temperature: -40 to +85C
- 8.4 mA Transmit Mode (+5 dBm)
- 7.4 mA Receive Mode
- 1µA Standby (SRAM/CPU retention and RTC running) with quick 100 µs start up
- 200nA Shutdown
- 61µA/MHz Active CPU Current
- Drivers, Bluetooth Low Energy Controller, and bootloader in ROM
- Flexible peripheral set
- On board 32 kHz and 24 MHz Crystals
- Worldwide Acceptance: FCC (USA), IC (Canada), ETSI (Europe), Giteki (Japan), and C-Tick (AU/NZ)
- REACH and RoHS compliant

### APPLICATIONS

- Consumer electronics
- Mobile phone accessories
- Sports & Fitness equipment
- HID applications
- Home and Building Automation, Lighting Control, Alarm and Security
- Electronic Shelf Labeling, Proximity Tags

### DESCRIPTION

LSR would like to announce a low-cost and low-power consumption module which has all of the *Bluetooth Smart* 4.1 functionalities.



The SaBLE-x module fully supports the single mode *Bluetooth Low Energy* operation, and the output power can support class 2. The module provides the ability to either put your entire application into the integrated ARM Cortex M3 microcontroller, or use the module in Network Processor mode in conjunction with the microcontroller of your choice. RF Core's dedicated ARM Cortex M0 improves system performance and frees up FLASH memory for custom applications.

Need to get to market quickly? Not an expert in *Bluetooth Low Energy*? Need a custom antenna? Do you need help with your host board? LSR Design Services will be happy to develop custom hardware or software, or help integrate the design. Contact us at [sales@lsr.com](mailto:sales@lsr.com) or call us at 262-375-4400.

**ORDERING INFORMATION**

<b>Order Number</b>	<b>Description</b>
450-0119C	SaBLE-x Module, PCB Trace Antenna (Cut Tape)
450-0119R	SaBLE-x Module, PCB Trace Antenna (Tape & Reel)
450-0144C	SaBLE-x Module, External Antenna Port (Cut Tape)
450-0144R	SaBLE-x Module, External Antenna Port (Tape & Reel)
450-0150	SaBLE-x Evaluation Kit, PCB Trace Antenna
450-0141	SaBLE-x Development Kit, PCB Trace Antenna

**Table 1 Orderable Model Numbers**

MODULE ACCESSORIES





	Order Number	Description
	001-0001	2.4 GHz Dipole Antenna with Reverse Polarity SMA Connector
	080-0001	U.FL to Reverse Polarity SMA Bulkhead Cable 105mm
	001-0014	2.4 GHz FlexPIFA Antenna
	001-0015	2.4 GHz FlexNotch Antenna

Table 2 Module Accessories

The information in this document is subject to change without notice.

**BLOCK DIAGRAM**

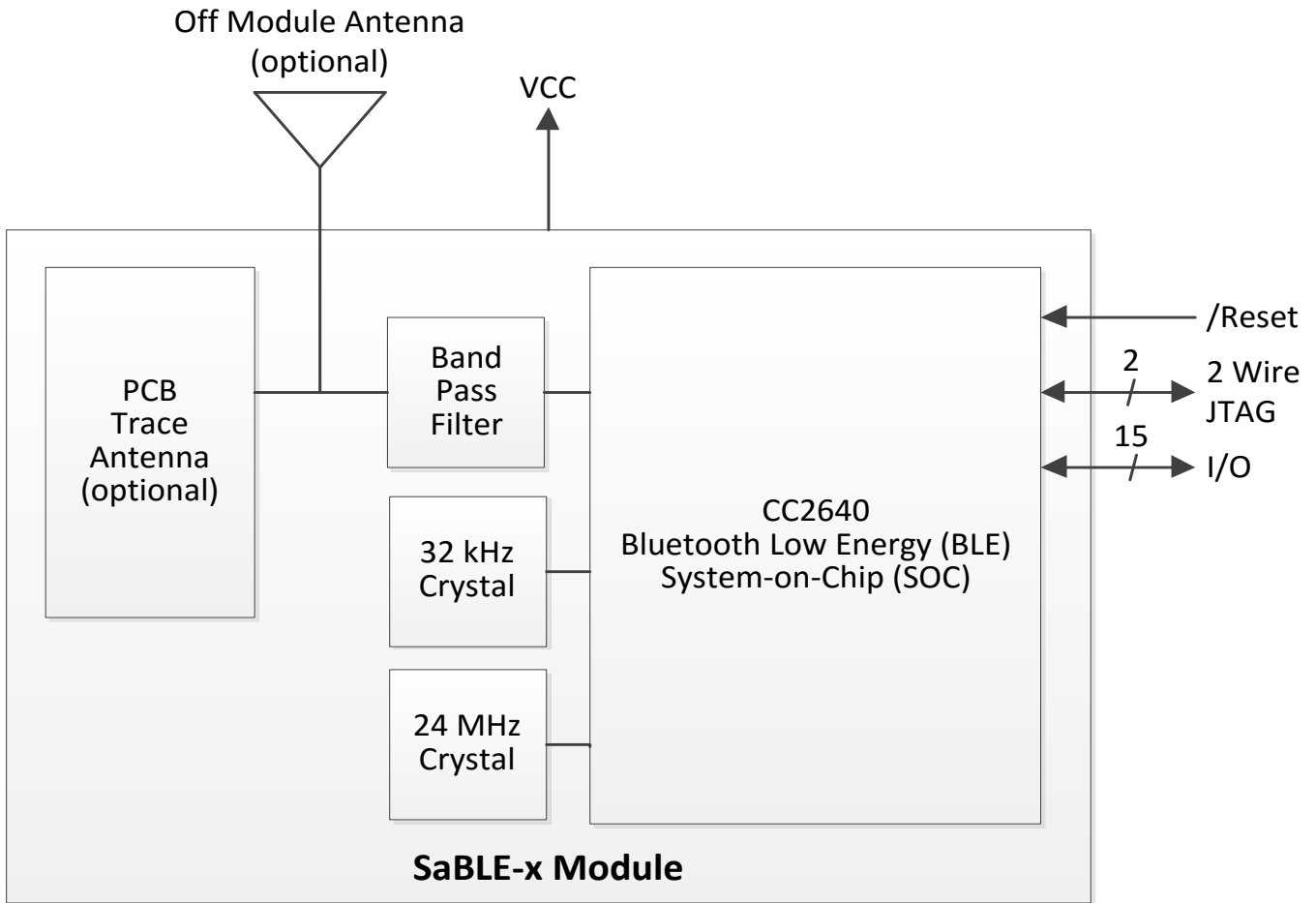

**Figure 1 SaBLE-x Module Block Diagram**

---

**TABLE OF CONTENTS**

---

<b>FEATURES .....</b>	<b>1</b>
<b>APPLICATIONS .....</b>	<b>1</b>
<b>DESCRIPTION .....</b>	<b>1</b>
<b>ORDERING INFORMATION .....</b>	<b>2</b>
<b>MODULE ACCESSORIES.....</b>	<b>3</b>
<b>BLOCK DIAGRAM .....</b>	<b>4</b>
<b>FOOTPRINT AND PIN DEFINITIONS .....</b>	<b>7</b>
<b>PIN DESCRIPTIONS .....</b>	<b>8</b>
<b>ELECTRICAL SPECIFICATIONS .....</b>	<b>9</b>
<b>Absolute Maximum Ratings .....</b>	<b>9</b>
<b>Recommended Operating Conditions .....</b>	<b>9</b>
<b>General Characteristics .....</b>	<b>9</b>
<b>DC Characteristics .....</b>	<b>10</b>
<b>General Power Consumption .....</b>	<b>11</b>
<b>RF Characteristics .....</b>	<b>12</b>
<b>Wakeup Timing.....</b>	<b>13</b>
<b>MODULE OUTPUT CONFIGURATION .....</b>	<b>15</b>
<b>SOLDERING RECOMMENDATIONS .....</b>	<b>17</b>
<b>Recommended Reflow Profile for Lead Free Solder .....</b>	<b>17</b>
<b>CLEANING .....</b>	<b>18</b>
<b>OPTICAL INSPECTION .....</b>	<b>18</b>
<b>REWORK .....</b>	<b>18</b>
<b>SHIPPING, HANDLING, AND STORAGE .....</b>	<b>18</b>
<b>Shipping.....</b>	<b>18</b>
<b>Handling .....</b>	<b>18</b>
<b>Moisture Sensitivity Level (MSL) .....</b>	<b>18</b>
<b>Storage .....</b>	<b>18</b>

---

The information in this document is subject to change without notice.

---

Repeating Reflow Soldering.....	19
<b>AGENCY CERTIFICATIONS .....</b>	<b>20</b>
<b>AGENCY STATEMENTS.....</b>	<b>20</b>
Federal Communication Commission Interference Statement .....	20
Industry Canada Statements.....	21
<b>OEM RESPONSIBILITIES TO COMPLY WITH FCC AND INDUSTRY CANADA REGULATIONS.....</b>	<b>22</b>
<b>OEM LABELING REQUIREMENTS FOR END-PRODUCT .....</b>	<b>23</b>
<b>OEM END PRODUCT USER MANUAL STATEMENTS.....</b>	<b>24</b>
<b>EUROPE .....</b>	<b>25</b>
CE Notice .....	25
Declaration of Conformity (DOC) .....	25
<b>BLUETOOTH CERTIFICATION.....</b>	<b>25</b>
<b>ANTENNA INFORMATION.....</b>	<b>26</b>
LSR Dipole Antenna .....	26
LSR FlexPIFA .....	26
LSR FlexNotch .....	26
PCB Trace Antenna .....	26
<b>MECHANICAL DATA.....</b>	<b>37</b>
<b>PCB FOOTPRINT .....</b>	<b>38</b>
Tape & Reel Dimensions .....	39
<b>DEVICE MARKINGS .....</b>	<b>40</b>
Rev 1 Devices.....	40
Rev 2 Devices.....	40
Rev 3 Devices.....	41
<b>CONTACTING LSR .....</b>	<b>42</b>



PIN DESCRIPTIONS

Module Pin	Name	I/O Type	Description
1	RF OUT	RF	ANTENNA, 50 OHMS
2	GND	GND	GROUND
3	GND	GND	GROUND
4	NC	-	NO CONNECT (DO NOT CONNECT)
5	NC	-	NO CONNECT (DO NOT CONNECT)
6	/RESET	DI	ACTIVE LOW RESET. 100kΩ PULL-UP
7	JTAG TCKC	DI/DIO	JTAG TCKC
8	JTAG TMS	DIO	JTAG TMS
9	NC	-	NO CONNECT (DO NOT CONNECT)
10	NC	-	NO CONNECT (DO NOT CONNECT)
11	VCC	PI	POWER SUPPLY TO MODULE
12	VCC	PI	POWER SUPPLY TO MODULE
13	DIO 5/JTAG TDO	DIO	GPIO, JTAG TDO, LED DRIVING CAPABILITY
14	DIO 6/JTAG TDI	DIO	GPIO, JTAG TDI, LED DRIVING CAPABILITY
15	DIO 4	DIO	GPIO, ULP SENSOR INTERFACE, LED DRIVING CAPABILITY
16	DIO 3	DIO	GPIO, ULP SENSOR INTERFACE, LED DRIVING CAPABILITY
17	DIO 2	DIO	GPIO, ULP SENSOR INTERFACE, LED DRIVING CAPABILITY
18	DIO 1/BOOT RX	DIO	GPIO, ULP SENSOR INTERFACE, BOOTLOADER RX (UART0)
19	DIO 0/BOOT TX	DIO	GPIO, ULP SENSOR INTERFACE, BOOTLOADER TX (UART0)
20	DIO 7	DIO	GPIO, ANALOG INPUT, ULP SENSOR INTERFACE
21	DIO 8	DIO	GPIO, ANALOG INPUT, ULP SENSOR INTERFACE
22	GND	GND	GROUND
23	DIO 10	DIO	GPIO, ANALOG INPUT, ULP SENSOR INTERFACE
24	DIO 9	DIO	GPIO, ANALOG INPUT, ULP SENSOR INTERFACE
25	NC	-	NO CONNECT (DO NOT CONNECT)
26	NC	-	NO CONNECT (DO NOT CONNECT)
27	NC	-	NO CONNECT (DO NOT CONNECT)
28	NC	-	NO CONNECT (DO NOT CONNECT)
29	DIO 11	DIO	GPIO, ANALOG INPUT, ULP SENSOR INTERFACE
30	DIO 12	DIO	GPIO, ANALOG INPUT, ULP SENSOR INTERFACE
31	DIO 13	DIO	GPIO, ANALOG INPUT, ULP SENSOR INTERFACE
32	DIO 14	DIO	GPIO, ANALOG INPUT, ULP SENSOR INTERFACE
33	GND	GND	GROUND
34-39	GND	GND	GROUND AND THERMAL RELIEF PADS

PI = Power Input GND = Ground DI = Digital Input DO = Digital Output DIO = Digital Input/Output AI = Analog Input  
RF = Bi-directional RF Port Note: See the Texas Instruments CC2640 datasheet and user guide for further details on the I/O.

**Table 3 SaBLE-x Pin Descriptions**

The information in this document is subject to change without notice.



**ELECTRICAL SPECIFICATIONS**

**Absolute Maximum Ratings**

Symbol	Description	Min	Max	Unit
VCC	Digital Input Supply Voltage	-0.3	4.1	V
Voltage on any digital pin		-0.3	VCC+0.3, max 4.1	V
Input RF level			+5	dBm

**Table 4 Absolute Maximum Ratings<sup>1</sup>**

**Recommended Operating Conditions**

Test conditions: Ambient Temp = 25°C

Symbol	Min	Typ	Max	Unit
VCC	1.8	3.3	3.8	V

**Table 5 Recommended Operating Conditions**

**General Characteristics**

Characteristic	Description
Model Name	SaBLE-x
Product Description	Bluetooth Low Energy Wireless Module
Dimension	11.63 mm x 17.86 mm x 2.4 mm (W*L*T)
Operating temperature	-40°C to 85°C
Storage temperature	-40°C to 85°C
Humidity	Operating Humidity 10% to 95% Non-Condensing Storage Humidity 5% to 95% Non-Condensing
Weight	0.75g +/- 0.05g

**Table 6 General Characteristics**

<sup>1</sup> Under no circumstances should exceeding the ratings specified in the Absolute Maximum Ratings section be allowed. Stressing the module beyond these limits may result permanent damage to the module that is not covered by the warranty.

DC Characteristics

Parameter	Test Conditions	Min	Typ	Max	Unit
Input low-to-high transition with hysteresis	Transition from 0→1, T <sub>A</sub> = 25C, VCC=1.8V		1.07		V
Input high-to-low transition with hysteresis	Transition from 1→0, T <sub>A</sub> = 25C, VCC=1.8V		0.74		V
Input hysteresis	Difference between 0→1 and 1→0.		0.33		V
Input low-to-high transition with hysteresis	Transition from 0→1, T <sub>A</sub> = 25C, VCC=3.8V		1.94		V
Input high-to-low transition with hysteresis	Transition from 1→0, T <sub>A</sub> = 25C, VCC=3.8V		1.54		V
Input hysteresis	Difference between 0→1 and 1→0.		0.40		V
Logic-0 output voltage, 4 mA pins	Output load 4 mA, T <sub>A</sub> = 25C, VCC=1.8V		0.26		V
Logic-1 output voltage, 4 mA pins	Output load 4 mA, T <sub>A</sub> = 25C, VCC=1.8V		1.54		V
Logic-0 output voltage, 8 mA pins	Output load 8 mA, T <sub>A</sub> = 25C, VCC=1.8V		0.21		V
Logic-1 output voltage, 8 mA pins	Output load 8 mA, T <sub>A</sub> = 25C, VCC=1.8V		1.58		V
Logic-0 output voltage, 4 mA pins	Output load 4 mA, T <sub>A</sub> = 25C, VCC=3.0V		0.33		V
Logic-1 output voltage, 4 mA pins	Output load 4 mA, T <sub>A</sub> = 25C, VCC=3.0V		2.72		V
Logic-0 output voltage, 8 mA pins	Output load 8 mA, T <sub>A</sub> = 25C, VCC=3.0V		0.28		V
Logic-1 output voltage, 8 mA pins	Output load 8 mA, T <sub>A</sub> = 25C, VCC=3.0V		2.68		V
Input pullup current	V <sub>pad</sub> =0V, T <sub>A</sub> = 25C, VCC=1.8V		72		uA
Input pulldown current	V <sub>pad</sub> =1.8V, T <sub>A</sub> = 25C, VCC=1.8V		22		uA
Input pullup current	V <sub>pad</sub> =0V, T <sub>A</sub> = 25C, VCC=3.8V		277		uA
Input pulldown current	V <sub>pad</sub> =3.8V, T <sub>A</sub> = 25C, VCC=3.8V		113		uA

Table 7 SaBLE-x Module Bluetooth General DC Characteristics

### General Power Consumption

T<sub>A</sub> = 25°C

Parameter	Test Conditions	Min	Typical Average Current				Max	Unit
			1.8V	3.0V	3.3V	3.8V		
Shutdown	No clocks running, no data retention				200			nA
Standby 1	With RTC, CPU, RAM and partial register retention. XOSC_LF				1.2			uA
Standby 2	With Cache, RTC, CPU, RAM and partial register retention. XOSC_LF				2.7			uA
Idle	Supply Systems and RAM powered.				550			uA
Active	Core running CoreMark				1.45mA + 31uA/MHz			
Radio Recieve			11.8	7.9	7.4	7.0		mA
Radio Transmit	+5 dBm output power		13.6	9.0	8.4	7.9		

**Table 8 SaBLE-x Module Bluetooth TX & RX Current Consumption Specifications**

### RF Characteristics

Measured on LSR SaBLE-x External Antenna Development Board reference design, with  $T_A = 25^\circ\text{C}$ ,  $V_{DD} = 3.3\text{ V}$ ,  $f_c = 2440\text{ MHz}$ , LEDs disabled, DC to DC disabled, measured at RF connector.

Parameter	Test Conditions	Min	Typical				Max	Unit
			1.8V	3.0V	3.3V	3.8V		
<b>TRANSMIT SECTION</b>								
Output Power	CH 0 (2402 MHz)		5.3	5.2	5.3	5.3		dBm
	CH 19 (2440 MHz)		4.7	4.7	4.7	4.8		
	CH 39 (2480 MHz)		4.4	4.6	4.5	4.6		
Spurious emission conducted measurement	$f < 1\text{ GHz}$		-43					dBm
	$f > 1\text{ GHz}$		-46					dBm
RF frequency range	Programmable in 1-MHz steps	2402					2480	MHz
<b>RECEIVE SECTION</b>								
Receiver sensitivity	CH 0 (2402 MHz)		-96.1	-95.7	-94.4	-93.8		dBm
	CH 19 (2440 MHz)		-95.8	-95.6	-95.0	-94.5		
	CH 39 (2480 MHz)		-95.9	-95.7	-95.3	-95.0		
Saturation	BER < 0.1%				4		dBm	
Co-channel rejection	Wanted signal -67 dBm				-6		dB	
Frequency error tolerance	Including both initial tolerance and drift. Sensitivity better than -67dBm, 250 byte payload. BER 0.1%	-250					250	KHz
Intermodulation	Minimum interferer level				-36		dBm	

Table 9 Bluetooth RF Characteristics

## Wakeup Timing

### Shutdown

Shutdown is similar to holding the device in reset with two exceptions:

1. It latches the state of IO prior to shutting down.
2. It consumes 0.1 uA, versus approximately 37 uA.

**Figure 3** shows the response time to wake up from shutdown by using a wake up pin. The pin is configured to wake the device up on a negative edge. Once the device wakes it drives an awake pin low:

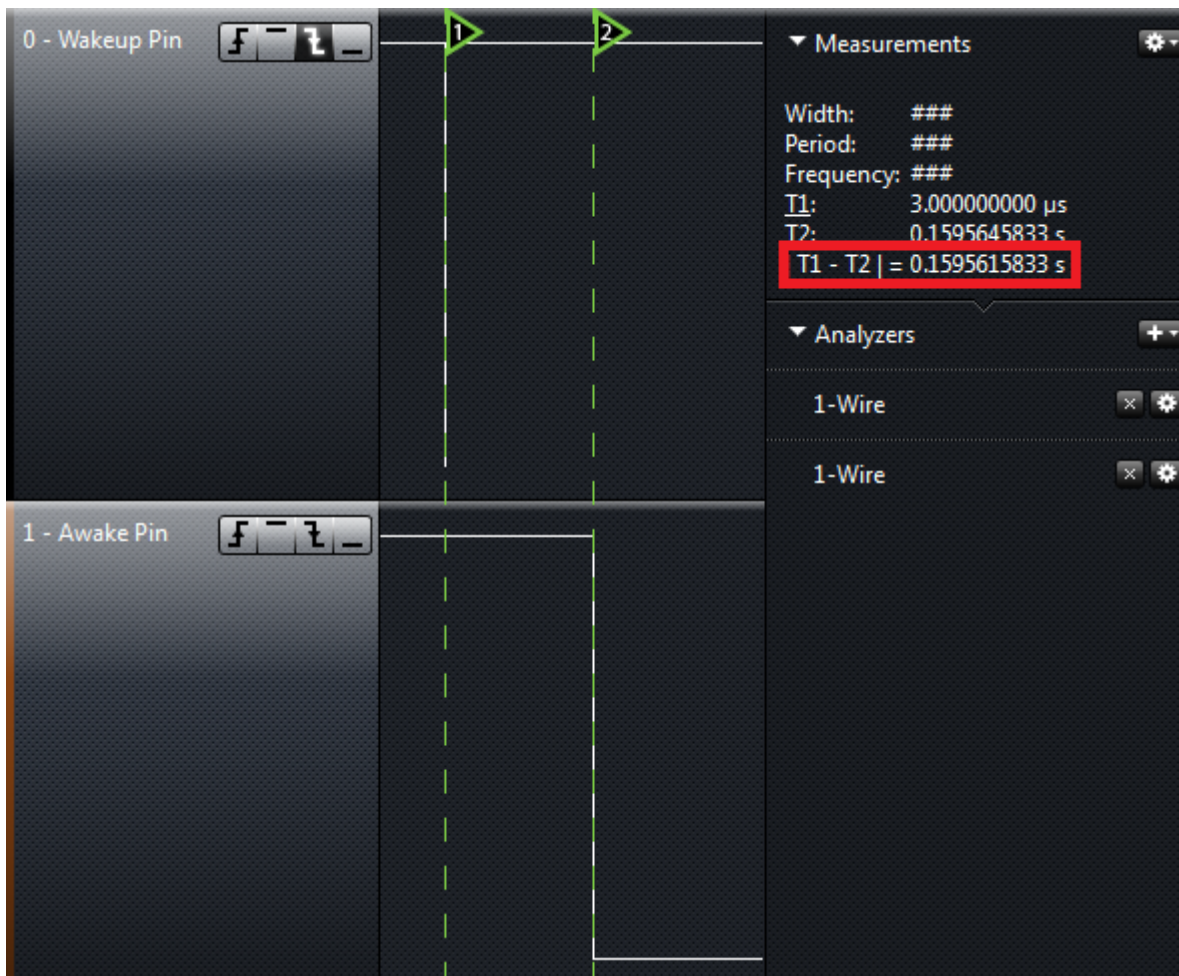

**Figure 3 SaBLE-x Module Waking from Shutdown Timing Diagram**

In **Figure 3** it shows the module taking approximately 160ms to wake.

### Standby

Standby is a low power mode policy. When configured correctly in code the software goes into standby.

**Figure 4** shows the response time to wake up from standby using a wake up pin. The method is the same as described in the shutdown section:

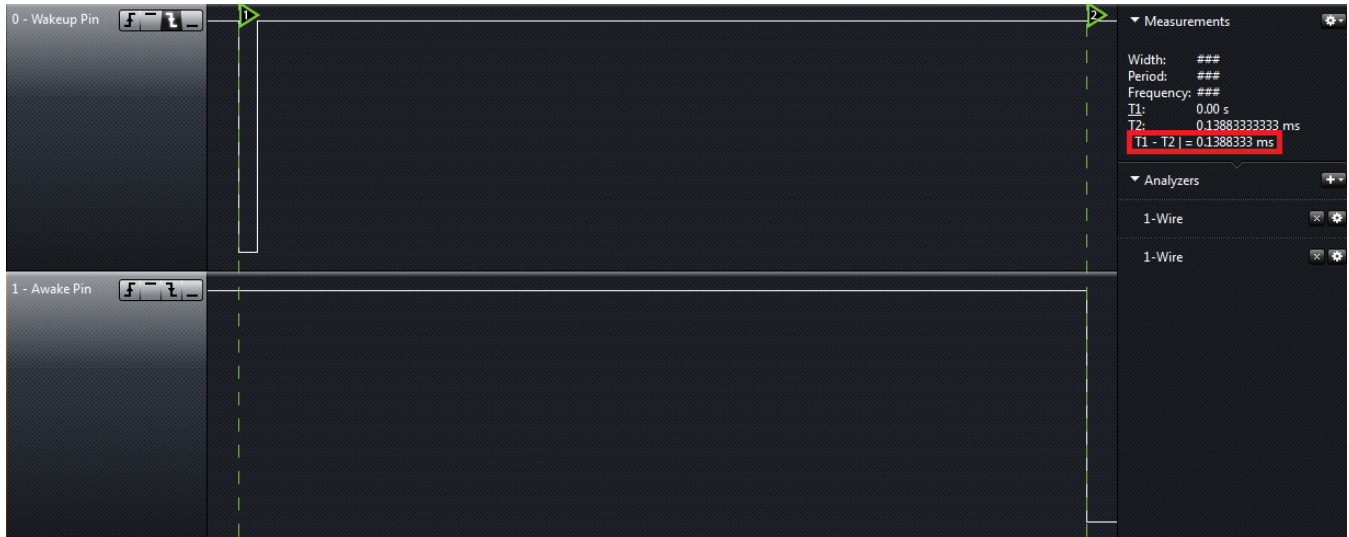
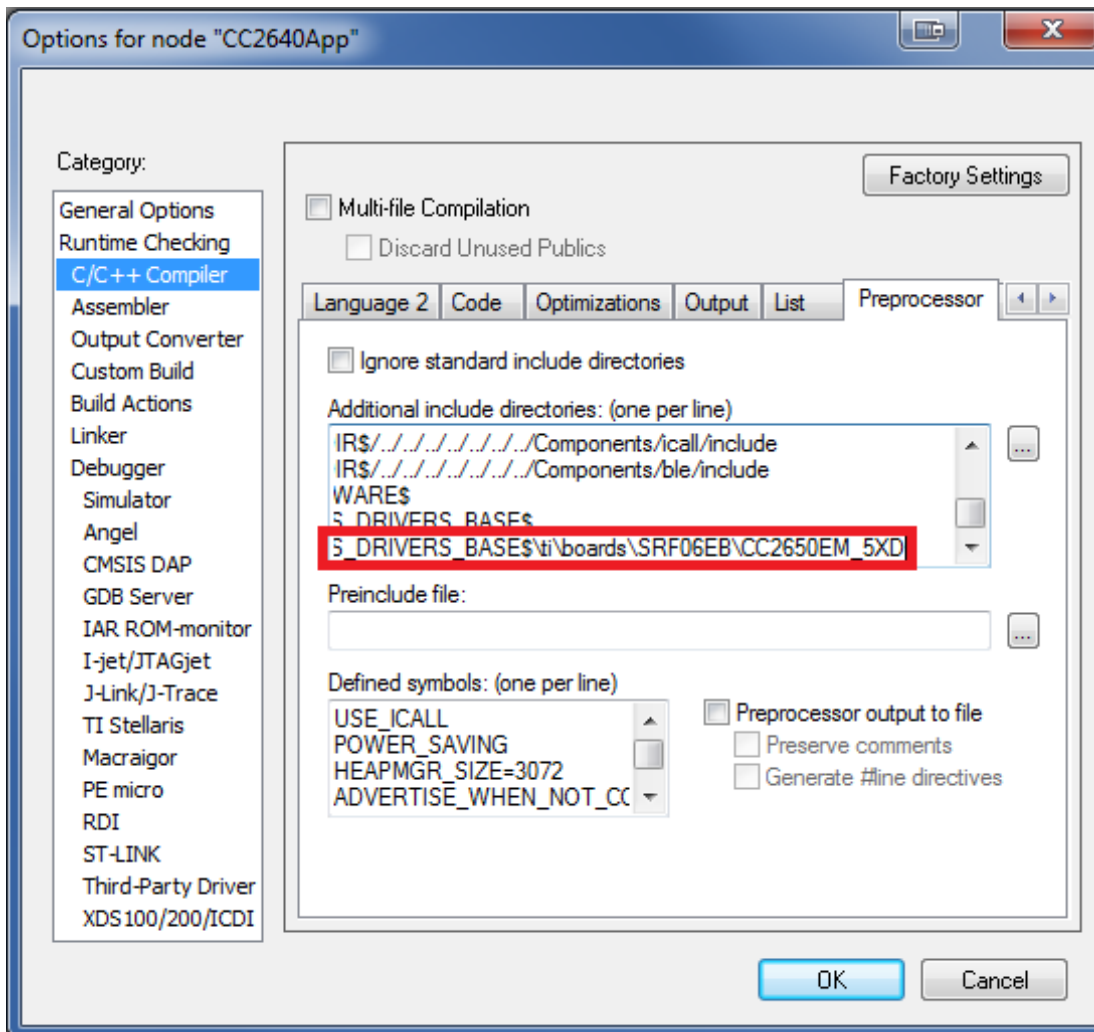

**Figure 4 SaBLE-x Module Waking from Standby Timing Diagram**

In **Figure 4** it shows the module taking approximately 139 us to wake.

**MODULE OUTPUT CONFIGURATION**

The SaBLE-x module uses the CC2640 5x5 mm RHB package with 15 GPIOs and the RF front end was configured as differential output with external bias. In order to configure the proper biasing, the correct package type must be selected in software. This configuration also selects the correct board file for the SaBLE-x module. To make this change the application compiler include options must be changed from 7ID to 5XD. Refer to **Figure 5**. The corresponding board file is located at that directory as well.



**Figure 5 Selection of SaBLE-x Package Type**

Furthermore, the default transmit power on boot can be set in bleUserConfig.c:

```
// Default Tx Power Index
#define DEFAULT_TX_POWER          12
```

Figure 6 Selection of SaBLE-x Default Tx Power on Boot

This value is the index into the following table in bleUserConfig.c:

```
// Tx Power Values (Pout, IB, GC, TC)
const txPwrVal_t txPowerTable[] =
{ { TX_POWER_MINUS_21_DBM, GEN_TX_POWER_VAL( 0x07, 3, 0x0C ) },
  { TX_POWER_MINUS_18_DBM, GEN_TX_POWER_VAL( 0x09, 3, 0x0C ) },
  { TX_POWER_MINUS_15_DBM, GEN_TX_POWER_VAL( 0x0B, 3, 0x0C ) },
  { TX_POWER_MINUS_12_DBM, GEN_TX_POWER_VAL( 0x0B, 1, 0x14 ) },
  { TX_POWER_MINUS_9_DBM, GEN_TX_POWER_VAL( 0x0E, 1, 0x19 ) },
  { TX_POWER_MINUS_6_DBM, GEN_TX_POWER_VAL( 0x12, 1, 0x1D ) },
  { TX_POWER_MINUS_3_DBM, GEN_TX_POWER_VAL( 0x18, 1, 0x25 ) },
  { TX_POWER_0_DBM, GEN_TX_POWER_VAL( 0x21, 1, 0x31 ) },
  { TX_POWER_1_DBM, GEN_TX_POWER_VAL( 0x14, 0, 0x42 ) },
  { TX_POWER_2_DBM, GEN_TX_POWER_VAL( 0x18, 0, 0x4E ) },
  { TX_POWER_3_DBM, GEN_TX_POWER_VAL( 0x1C, 0, 0x5A ) },
  { TX_POWER_4_DBM, GEN_TX_POWER_VAL( 0x24, 0, 0x93 ) },
  { TX_POWER_5_DBM, GEN_TX_POWER_VAL( 0x30, 0, 0x93 ) } };
```

Figure 7 Table Indexed by DEFAULT\_TX\_POWER Value



**SOLDERING RECOMMENDATIONS**

**Recommended Reflow Profile for Lead Free Solder**

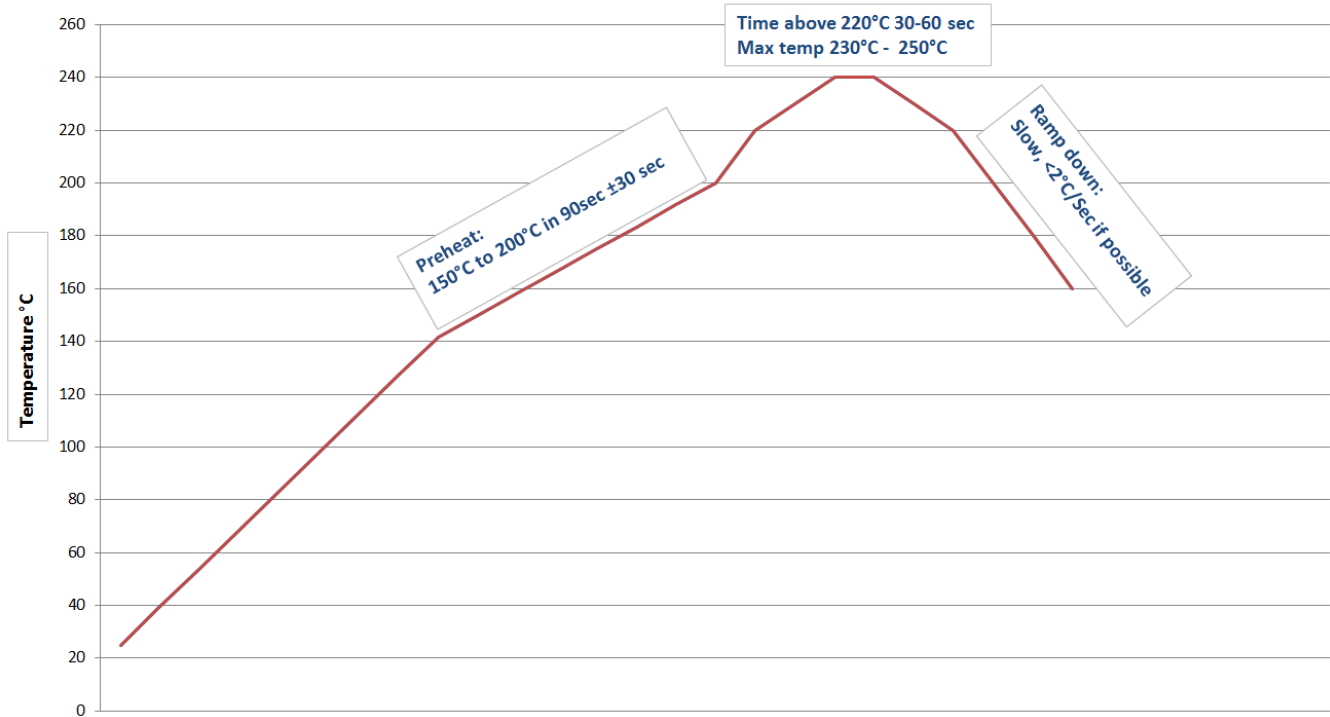

Figure 8 Recommended Soldering Profile

**Note: The quality of solder joints on the surface mount pads where they contact the host board should meet the appropriate IPC Specification. See IPC-A-610-D Acceptability of Electronic Assemblies, section 8.2.1 "Bottom Only Terminations."**

## CLEANING

In general, cleaning the populated modules is strongly discouraged. Residuals under the module cannot be easily removed with any cleaning process.

- Cleaning with water can lead to capillary effects where water is absorbed into the gap between the host board and the module. The combination of soldering flux residuals and encapsulated water could lead to short circuits between neighboring pads. Water could also damage any stickers or labels.
- Cleaning with alcohol or a similar organic solvent will likely flood soldering flux residuals into the RF shield, which is not accessible for post-washing inspection. The solvent could also damage any stickers or labels.
- Ultrasonic cleaning could damage the module permanently.

## OPTICAL INSPECTION

After soldering the Module to the host board, consider optical inspection to check the following:

- Proper alignment and centering of the module over the pads.
- Proper solder joints on all pads.
- Excessive solder or contacts to neighboring pads, or vias.

## REWORK

The module can be unsoldered from the host board if the Moisture Sensitivity Level (MSL) requirements are met as described in this datasheet.

**Never attempt a rework on the module itself, e.g. replacing individual components. Such actions will terminate warranty coverage.**

## SHIPPING, HANDLING, AND STORAGE

### Shipping

Bulk orders of the SaBLE-x modules are delivered in reels of 1,000.

### Handling

The SaBLE-x modules contain a highly sensitive electronic circuitry. Handling without proper ESD protection may damage the module permanently.

### Moisture Sensitivity Level (MSL)

Per J-STD-020, devices rated as MSL 4 and not stored in a sealed bag with desiccant pack should be baked prior to use.

Devices are packaged in a Moisture Barrier Bag with a desiccant pack and Humidity Indicator Card (HIC). Devices that will be subjected to reflow should reference the HIC and J-STD-033 to determine if baking is required.

If baking is required, refer to J-STD-033 for bake procedure.

### Storage

Per J-STD-033, the shelf life of devices in a Moisture Barrier Bag is 12 months at <40°C and <90% room humidity (RH).

Do not store in salty air or in an environment with a high concentration of corrosive gas, such as Cl<sub>2</sub>, H<sub>2</sub>S, NH<sub>3</sub>, SO<sub>2</sub>, or NO<sub>x</sub>.

Do not store in direct sunlight.

The product should not be subject to excessive mechanical shock.

---

### Repeating Reflow Soldering

**Only a single reflow soldering process is encouraged for host boards.**

---

## AGENCY CERTIFICATIONS

FCC ID: TFB-1002, 15.247

IC ID: 5969A-1002, RSS 210

CE: Compliant to standards EN 60950-1, EN 300 328, and EN 301 489

Giteki: 209-J00169

RCM

## AGENCY STATEMENTS

### Federal Communication Commission Interference Statement

This equipment has been tested and found to comply with the limits for a Class B digital device, pursuant to Part 15 of the FCC Rules. These limits are designed to provide reasonable protection against harmful interference in a residential installation. This equipment generates uses and can radiate radio frequency energy and, if not installed and used in accordance with the instructions, may cause harmful interference to radio communications. However, there is no guarantee that interference will not occur in a particular installation. If this equipment does cause harmful interference to radio or television reception, which can be determined by turning the equipment off and on, the user is encouraged to try to correct the interference by one of the following measures:

- Reorient or relocate the receiving antenna.
- Increase the separation between the equipment and receiver.
- Connect the equipment into an outlet on a circuit different from that to which the receiver is connected.
- Consult the dealer or an experienced radio/TV technician for help.

This device complies with Part 15 of the FCC Rules. Operation is subject to the following two conditions: (1) This device may not cause harmful interference, and (2) this device must accept any interference received, including interference that may cause undesired operation.

This portable transmitter with its antenna complies with FCC/IC RF exposure limits for general population / uncontrolled exposure.

**FCC CAUTION: Any changes or modifications not expressly approved by the party responsible for compliance could void the user's authority to operate this equipment.**

### Industry Canada Statements

This device complies with Industry Canada License-exempt RSS standard(s). Operation is subject to the following two conditions: (1) this device may not cause interference, and (2) this device must accept any interference, including interference that may cause undesired operation of the device.

To reduce potential radio interference to other users, the antenna type and its gain should be so chosen that the equivalent isotropically radiated power (e.i.r.p.) is not more than that permitted for successful communication.

This device has been designed to operate with the antenna(s) listed below, and having a maximum gain of 0 dBi (PCB Trace), 2.0 dBi (LSR 2.4 GHz Dipole), 2.0 dBi (LSR 2.4 GHz FlexPIFA), and 2.0 (LSR 2.4 GHz FlexNotch). Antennas not included in this list or having a gain greater than 0 dB, 2.0 dBi, 2.0 dBi, and 2.0 dBi are strictly prohibited for use with this device. The required antenna impedance is 50 ohms.

List of all Antennas Acceptable for use with the Transmitter

- 1) On module PCB trace antenna.
- 2) LSR 001-0001 center-fed 2.4 GHz dipole antenna and LSR 080-0001 U.FL to Reverse Polarity SMA connector cable.
- 3) LSR 001-0014 2.4 GHz FlexPIFA antenna.
- 4) LSR 001-0015 2.4 GHz FlexNotch antenna.

Cet appareil est conforme aux normes d'Industrie Canada exempts de licence RSS (s). L'opération est soumise aux deux conditions suivantes: (1) cet appareil ne peut pas provoquer d'interférences et (2) cet appareil doit accepter toute interférence, y compris les interférences qui peuvent causer un mauvais fonctionnement de l'appareil.

Pour réduire le risque d'interférence aux autres utilisateurs, le type d'antenne et son gain doivent être choisis de manière que la puissance isotrope rayonnée équivalente (PIRE) ne dépasse pas celle permise pour une communication réussie.

Cet appareil a été conçu pour fonctionner avec l'antenne (s) ci-dessous, et ayant un gain maximum de 0 dBi (PCB Trace), 2,0 dBi (LSR 2.4 GHz Dipole), 2,0 dBi (LSR 2.4 GHz FlexPIFA), et 2,0 dBi (LSR 2.4 GHz FlexNotch). Antennes pas inclus dans cette liste ou présentant un gain supérieur à 0 dB, 2,0 dBi, 2,0 dBi, et 2,0 dBi sont strictement interdites pour une utilisation avec cet appareil. L'impédance d'antenne requise est de 50 ohms.

Liste de toutes les antennes acceptables pour une utilisation avec l'émetteur

- 1) Le module d'antenne PCB trace.
- 2) LSR 001-0001 centre-fed 2,4 GHz antenne dipôle et LSR 080-0001 U.FL pour inverser câble connecteur SMA à polarité.
- 3) LSR 001-0014 antenne FlexPIFA 2,4 GHz.
- 4) LSR 001-0015 antenne FlexNotch 2,4 GHz.

## OEM RESPONSIBILITIES TO COMPLY WITH FCC AND INDUSTRY CANADA REGULATIONS

The SaBLE-xModule has been certified for integration into products only by OEM integrators under the following conditions:

The antennas for this transmitter must not be co-located with any other transmitters except in accordance with FCC and Industry Canada multi-transmitter procedures. Co-location means having a separation distance of less than 20 cm between transmitting antennas.

As long as the two conditions above are met, further transmitter testing will not be required. However, the OEM integrator is still responsible for testing their end-product for any additional compliance requirements required with this module installed (for example, digital device emissions, PC peripheral requirements, etc.).

**IMPORTANT NOTE: In the event that these conditions cannot be met (for certain configurations or co-location with another transmitter), then the FCC and Industry Canada authorizations are no longer considered valid and the FCC ID and IC Certification Number cannot be used on the final product. In these circumstances, the OEM integrator will be responsible for re-evaluating the end product (including the transmitter) and obtaining a separate FCC and Industry Canada authorization.**

Le module de SaBLE-xa été certifié pour l'intégration dans des produits uniquement par des intégrateurs OEM dans les conditions suivantes:

Les antennes pour ce transmetteur ne doit pas être co-localisés avec les autres émetteurs sauf en conformité avec la FCC et Industrie Canada multi-émetteur procédures. Co-localisation des moyens ayant une distance de séparation inférieure à 20 cm entre les antennes d'émission.

Tant que les deux conditions précitées sont réunies, les tests de transmetteurs supplémentaires ne seront pas tenus. Toutefois, l'intégrateur OEM est toujours responsable de tester leur produit final pour toutes les exigences de conformité supplémentaires requis avec ce module installé (par exemple, les émissions appareil numérique, les exigences de périphériques PC, etc.)

**NOTE IMPORTANTE: Dans le cas où ces conditions ne peuvent être satisfaites (pour certaines configurations ou de co-implantation avec un autre émetteur), puis la FCC et Industrie autorisations Canada ne sont plus considérés comme valides et l'ID de la FCC et IC numéro de certification ne peut pas être utilisé sur la produit final. Dans ces circonstances, l'intégrateur OEM sera chargé de réévaluer le produit final (y compris l'émetteur) et l'obtention d'un distincte de la FCC et Industrie Canada l'autorisation.**

---

## OEM LABELING REQUIREMENTS FOR END-PRODUCT

The SaBLE-x module is labeled with its own FCC ID and IC Certification Number. The FCC ID and IC certification numbers are not visible when the module is installed inside another device, as such the end device into which the module is installed must display a label referring to the enclosed module. The final end product must be labeled in a visible area with the following:

**“Contains Transmitter Module FCC ID: TFB-1002”**

**“Contains Transmitter Module IC: 5969A-1002”**

or

**“Contains FCC ID: TFB-1002”**

**“Contains IC: 5969A-1002”**

The OEM of the SaBLE-x module must only use the approved antenna(s) listed above, which have been certified with this module.

Le module de SaBLE-x est étiqueté avec son propre ID de la FCC et IC numéro de certification. L'ID de la FCC et IC numéros de certification ne sont pas visibles lorsque le module est installé à l'intérieur d'un autre appareil, comme par exemple le terminal dans lequel le module est installé doit afficher une étiquette faisant référence au module ci-joint. Le produit final doit être étiqueté dans un endroit visible par le suivant:

**“Contient Module émetteur FCC ID: TFB-1002”**

**“Contient Module émetteur IC: 5969A-1002”**

ou

**“Contient FCC ID: TFB-1002”**

**“Contient IC: 5969A-1002”**

Les OEM du module SaBLE-x ne doit utiliser l'antenne approuvée (s) ci-dessus, qui ont été certifiés avec ce module.

---

**OEM END PRODUCT USER MANUAL STATEMENTS**

The OEM integrator should not provide information to the end user regarding how to install or remove this RF module or change RF related parameters in the user manual of the end product.

Other user manual statements may apply.

L'intégrateur OEM ne devraient pas fournir des informations à l'utilisateur final sur la façon d'installer ou de supprimer ce module RF ou modifier les paramètres liés RF dans le manuel utilisateur du produit final.

Autres déclarations manuel de l'utilisateur peuvent s'appliquer.



## EUROPE

### CE Notice

This device has been tested and certified for use in the European Union. See the Declaration of Conformity (DOC) for specifics.

If this device is used in a product, the OEM has responsibility to verify compliance of the final product to the EU standards. A Declaration of Conformity must be issued and kept on file as described in the Radio and Telecommunications Terminal Equipment (R&TTE) Directive.

The 'CE' mark must be placed on the OEM product per the labeling requirements of the Directive.

### Declaration of Conformity (DOC)

The DOC can be downloaded from the LSR Wiki.

## BLUETOOTH CERTIFICATION

The SaBLE-x module has been certified as a Component (Tested) and has a QDID of 66911.

**ANTENNA INFORMATION**

**LSR Dipole Antenna**

See antenna datasheet.

**LSR FlexPIFA**

See antenna datasheet.

**LSR FlexNotch**

See antenna datasheet.

**PCB Trace Antenna**

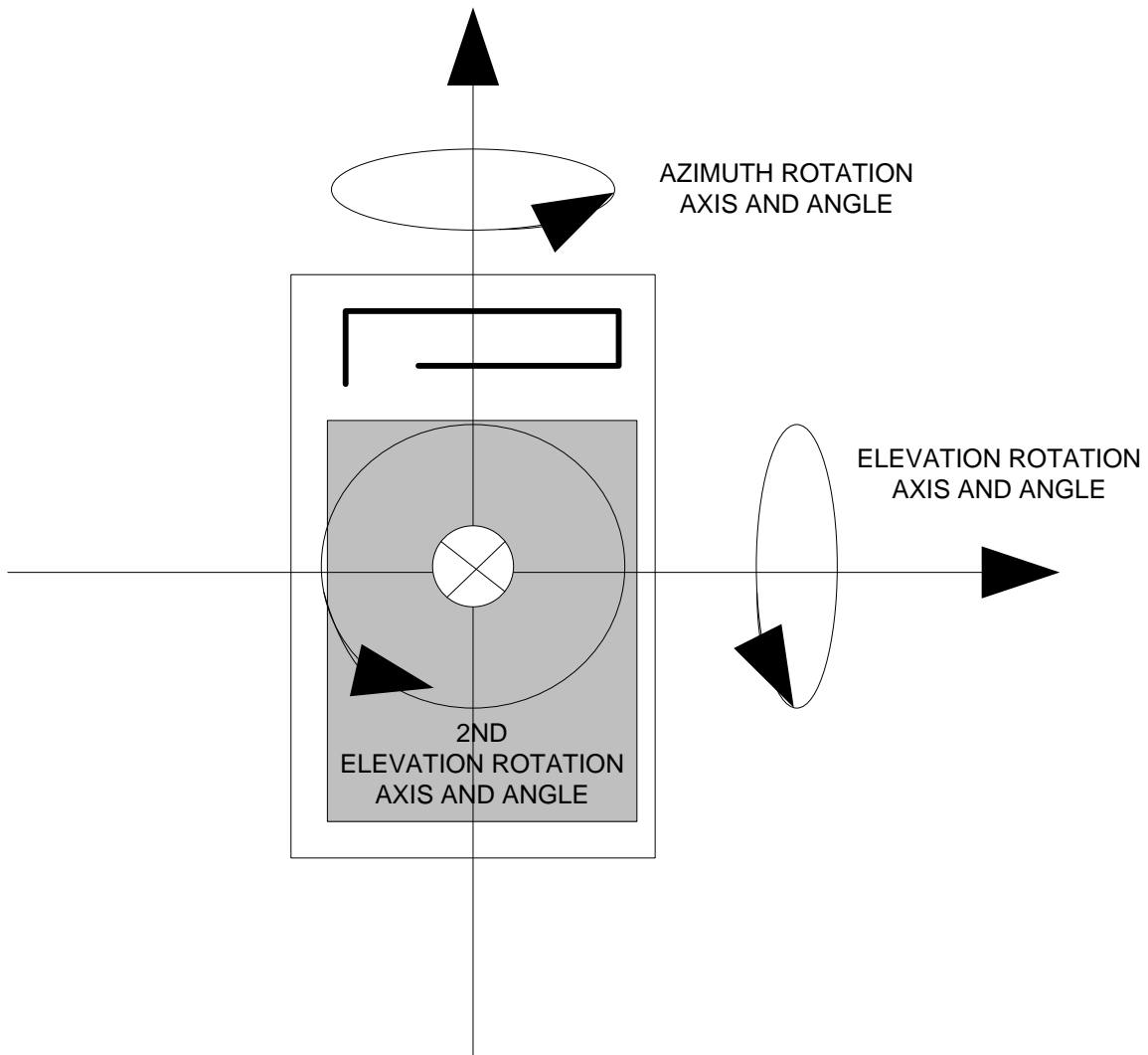

**Figure 9 PCB Trace Antenna Pattern Measurement Planes**

The information in this document is subject to change without notice.

Orientation	Frequency (MHz)	Polarization	Peak Gain (dBi)	Average Gain(dBi)	Average Total Gain (P) (dBi)	Average Total Gain - (F,P) (dBi)	Average Total Gain - (O,F,P) (dBi)
Azimuth	2402	Vertical	0.0	-3.6	-3.5	-5.1	-6.5
Azimuth	2402	Horizontal	-6.6	-13.5			
Azimuth	2440	Vertical	-1.7	-5.1	-4.8		
Azimuth	2440	Horizontal	-1.7	-13.4			
Azimuth	2480	Vertical	-4.3	-7.9	-7.9		
Azimuth	2480	Horizontal	-11.5	-15.9			
Elevation	2402	Vertical	-7.3	-11.4	-5.6	-6.8	
Elevation	2402	Horizontal	-1.2	-5.7			
Elevation	2440	Vertical	-7.9	-12.6	-6.5		
Elevation	2440	Horizontal	-7.9	-6.6			
Elevation	2480	Vertical	-11.0	-15.9	-6.5		
Elevation	2480	Horizontal	-4.2	-9.1			
2 <sup>nd</sup> Elevation	2402	Vertical	-7.3	-11.4	-7.2	-8.3	
2 <sup>nd</sup> Elevation	2402	Horizontal	-1.2	-5.7			
2 <sup>nd</sup> Elevation	2440	Vertical	-7.9	-12.6	-7.8		
2 <sup>nd</sup> Elevation	2440	Horizontal	-7.9	-6.6			
2 <sup>nd</sup> Elevation	2480	Vertical	-11.0	-15.9	-10.4		
2 <sup>nd</sup> Elevation	2480	Horizontal	-4.2	-9.1			

Table 10 PCB Trace Antenna Gain Summary

Vertical, Horizontal Antenna Patterns at 2402 MHz (dB) - Azimuth Cut

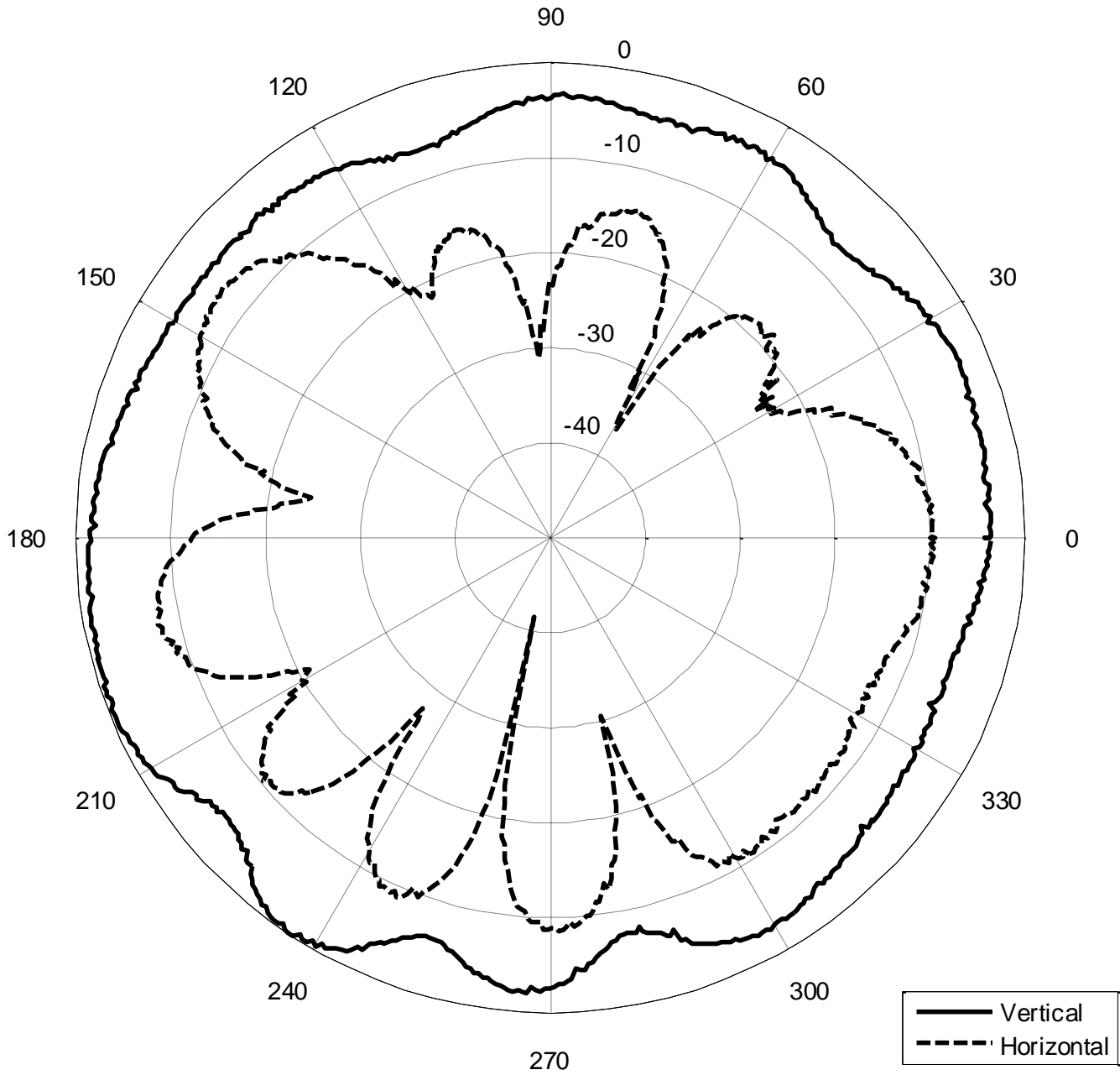

Figure 10 PCB Trace Antenna Pattern (Azimuth @ 2402 MHz)

Vertical, Horizontal Antenna Patterns at 2402 MHz (dB) - Elevation Cut

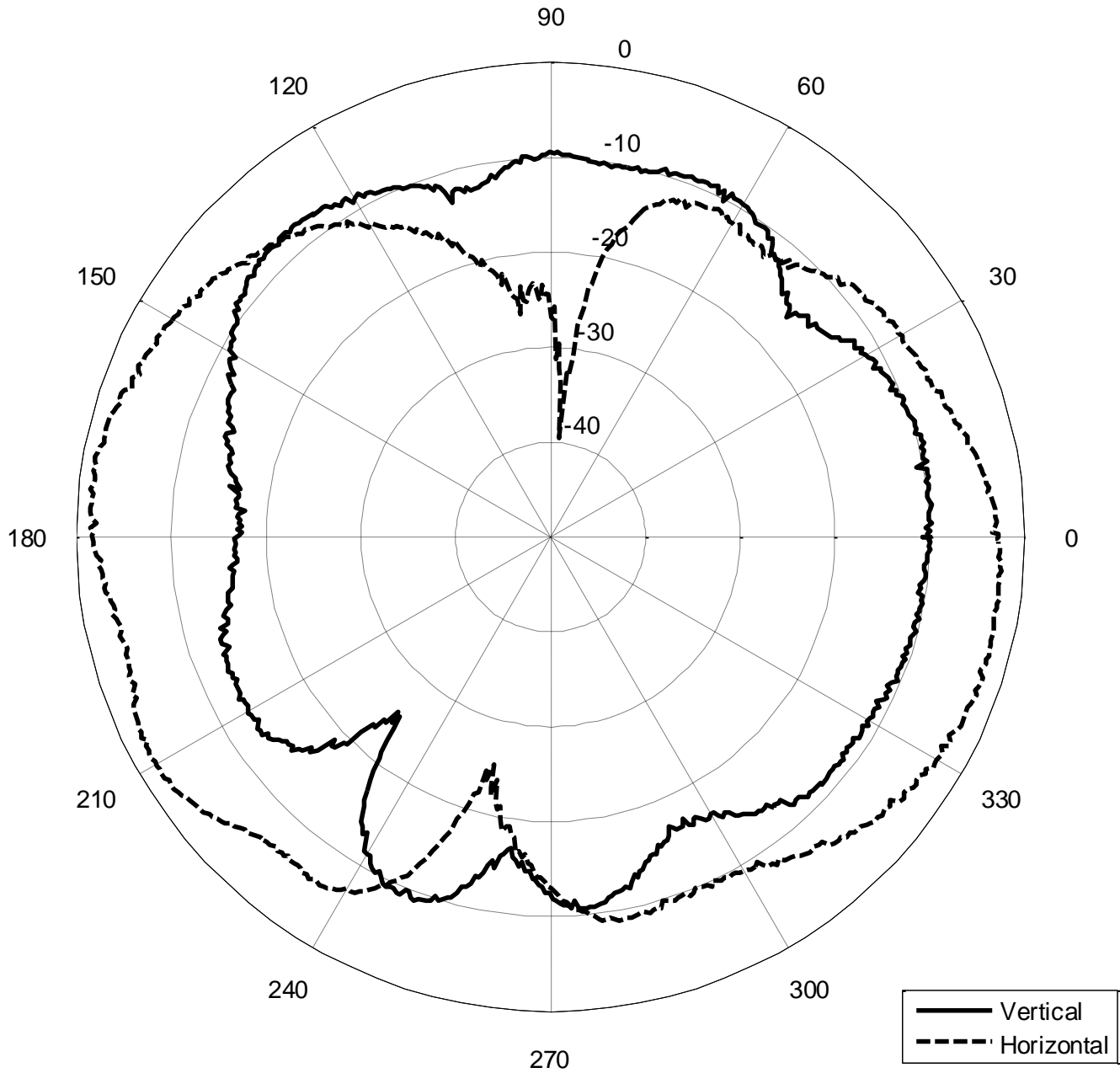

Figure 11 PCB Trace Antenna Pattern (Elevation @ 2402 MHz)

Vertical, Horizontal Antenna Patterns at 2402 MHz (dB) - Second Elevation Cut

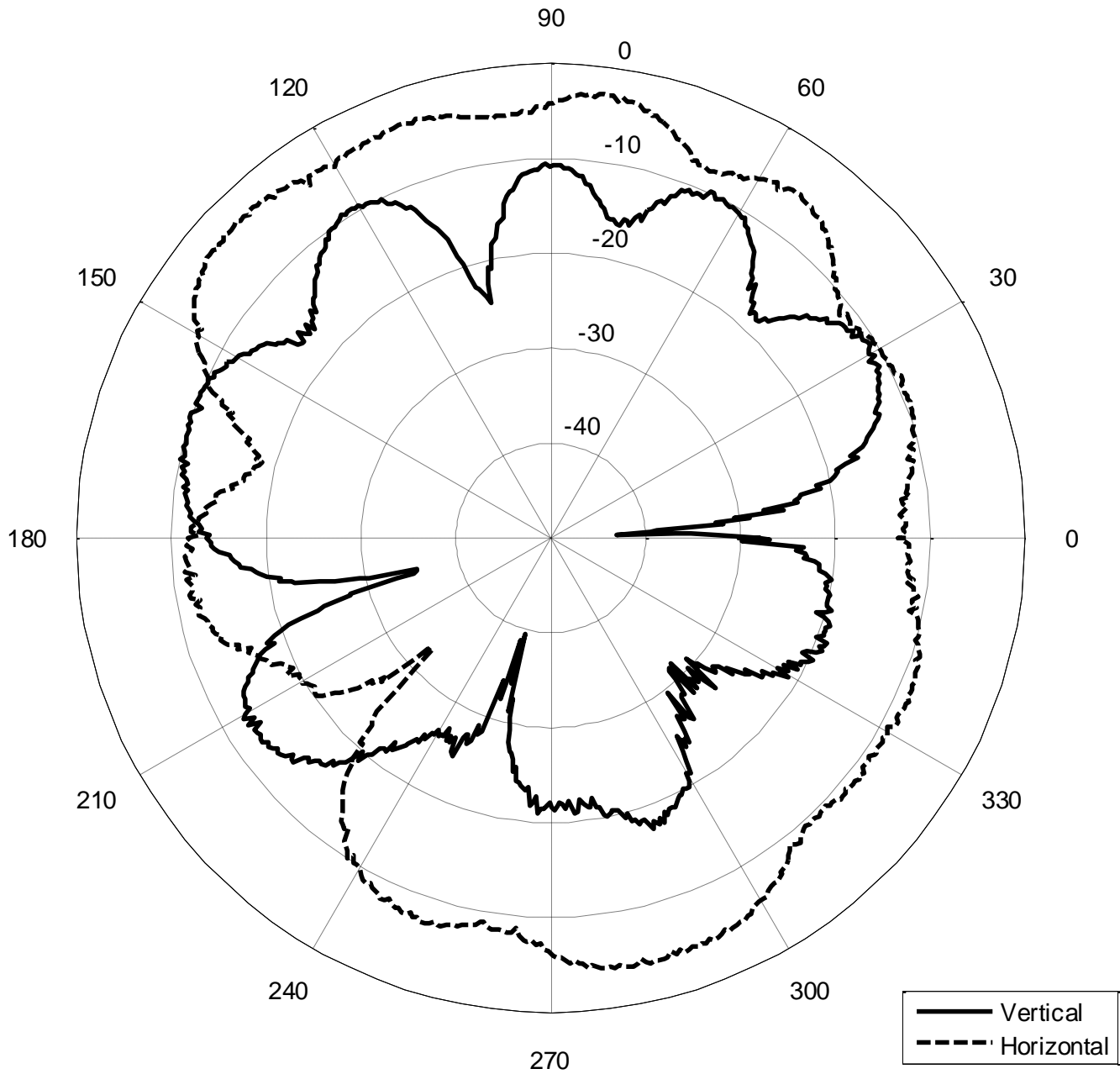

Figure 12 PCB Trace Antenna Pattern (2<sup>nd</sup> Elevation @ 2402 MHz)

Vertical, Horizontal Antenna Patterns at 2440 MHz (dB) - Azimuth Cut

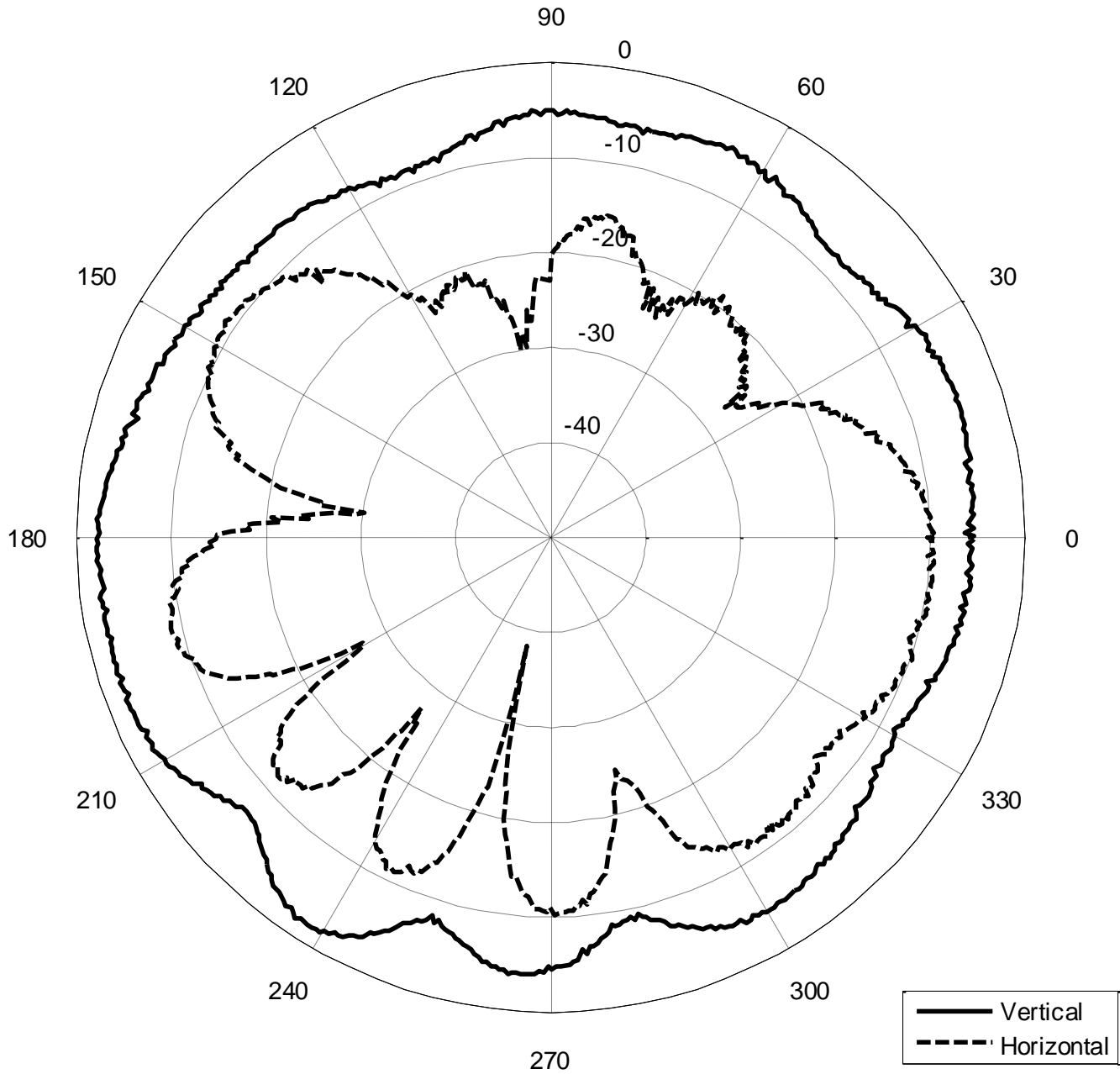

Figure 13 PCB Trace Antenna Pattern (Azimuth @ 2440 MHz)

Vertical, Horizontal Antenna Patterns at 2440 MHz (dB) - Elevation Cut

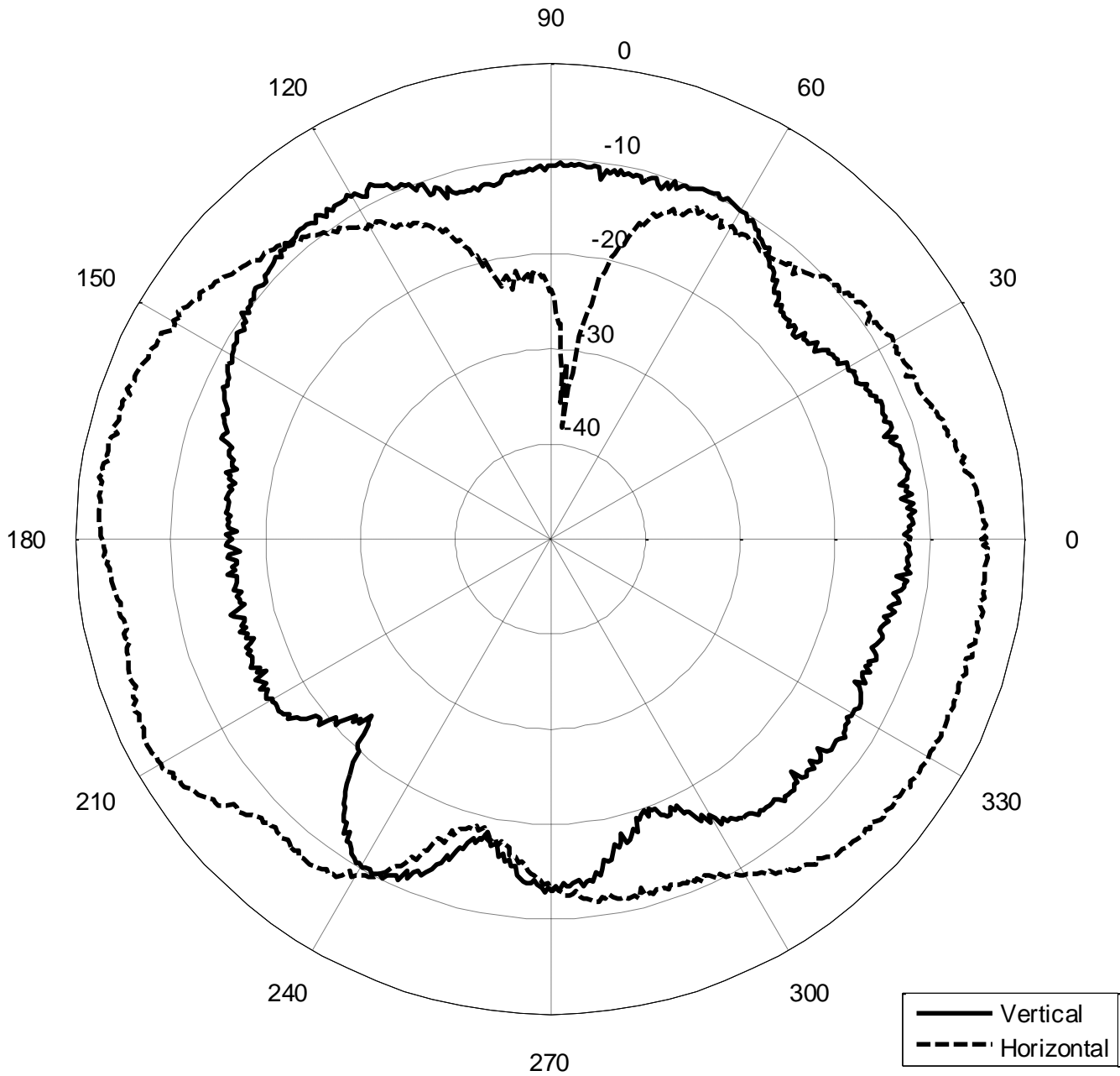

Figure 14 PCB Trace Antenna Pattern (Elevation @ 2440 MHz)



Vertical, Horizontal Antenna Patterns at 2440 MHz (dB) - Second Elevation Cut

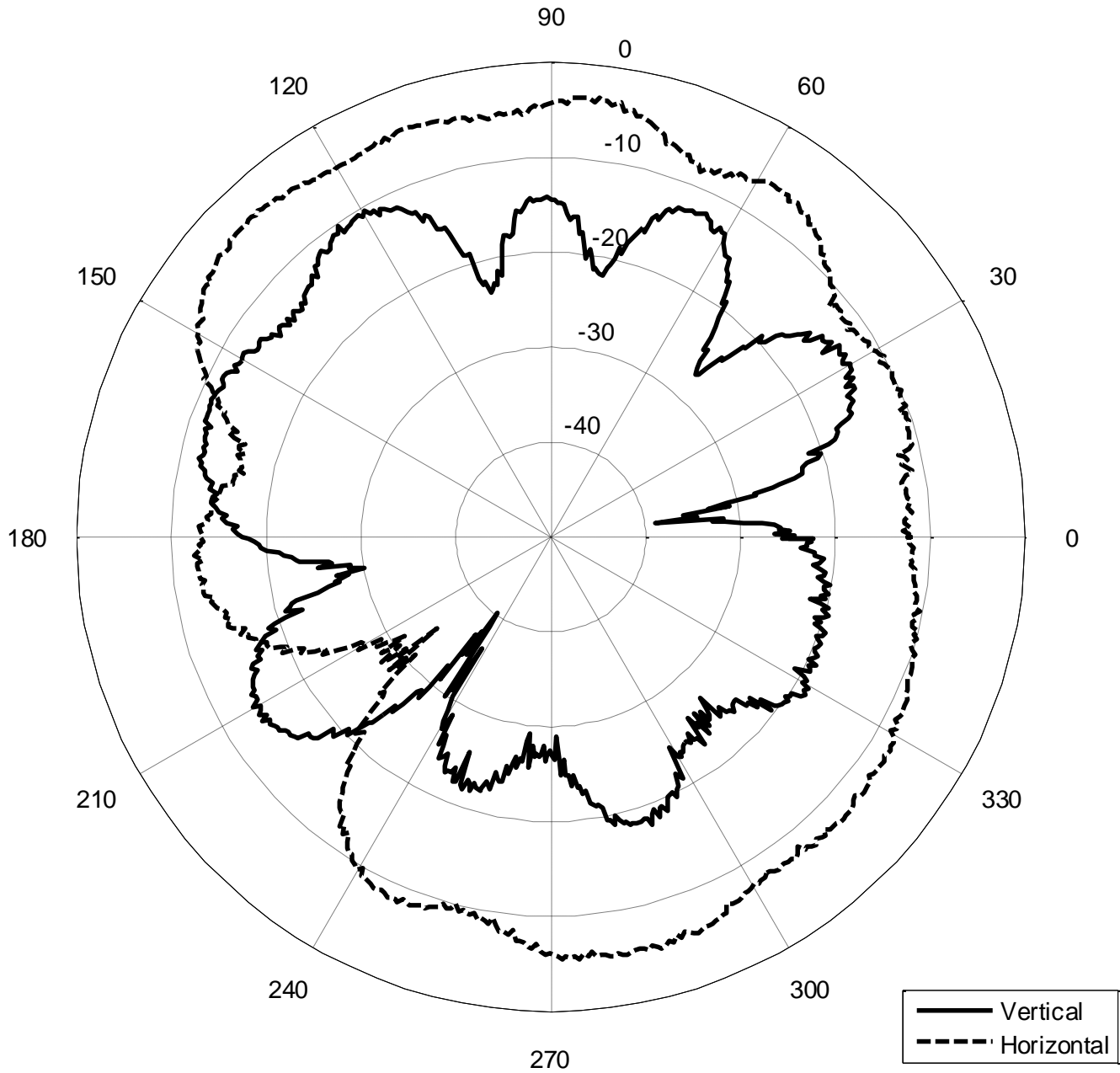

Figure 15 PCB Trace Antenna Pattern (2<sup>nd</sup> Elevation @ 2440 MHz)

Vertical, Horizontal Antenna Patterns at 2480 MHz (dB) - Azimuth Cut

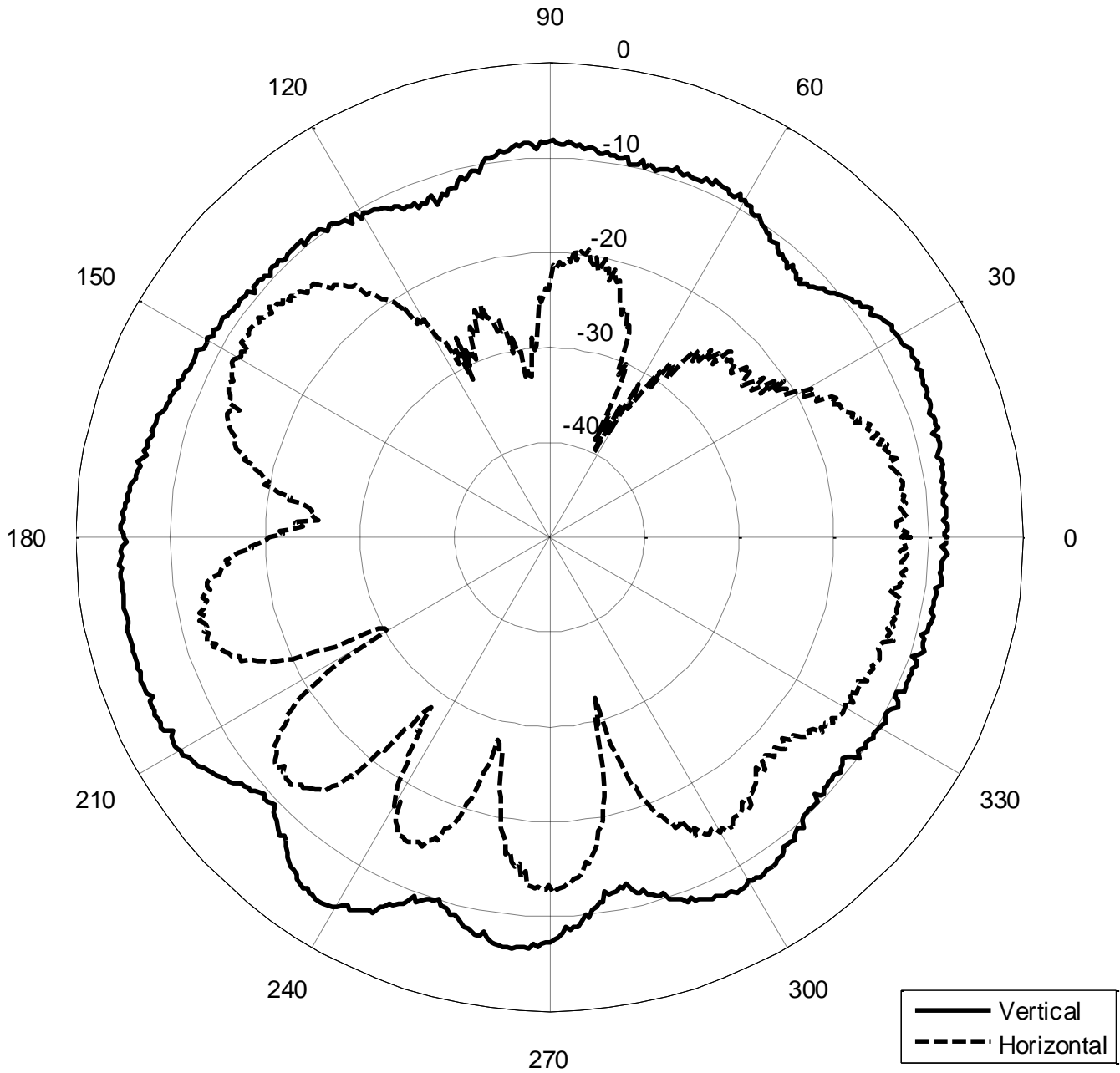

Figure 16 PCB Trace Antenna Pattern (Azimuth @ 2480 MHz)

Vertical, Horizontal Antenna Patterns at 2480MHz (dB) - Elevation Cut

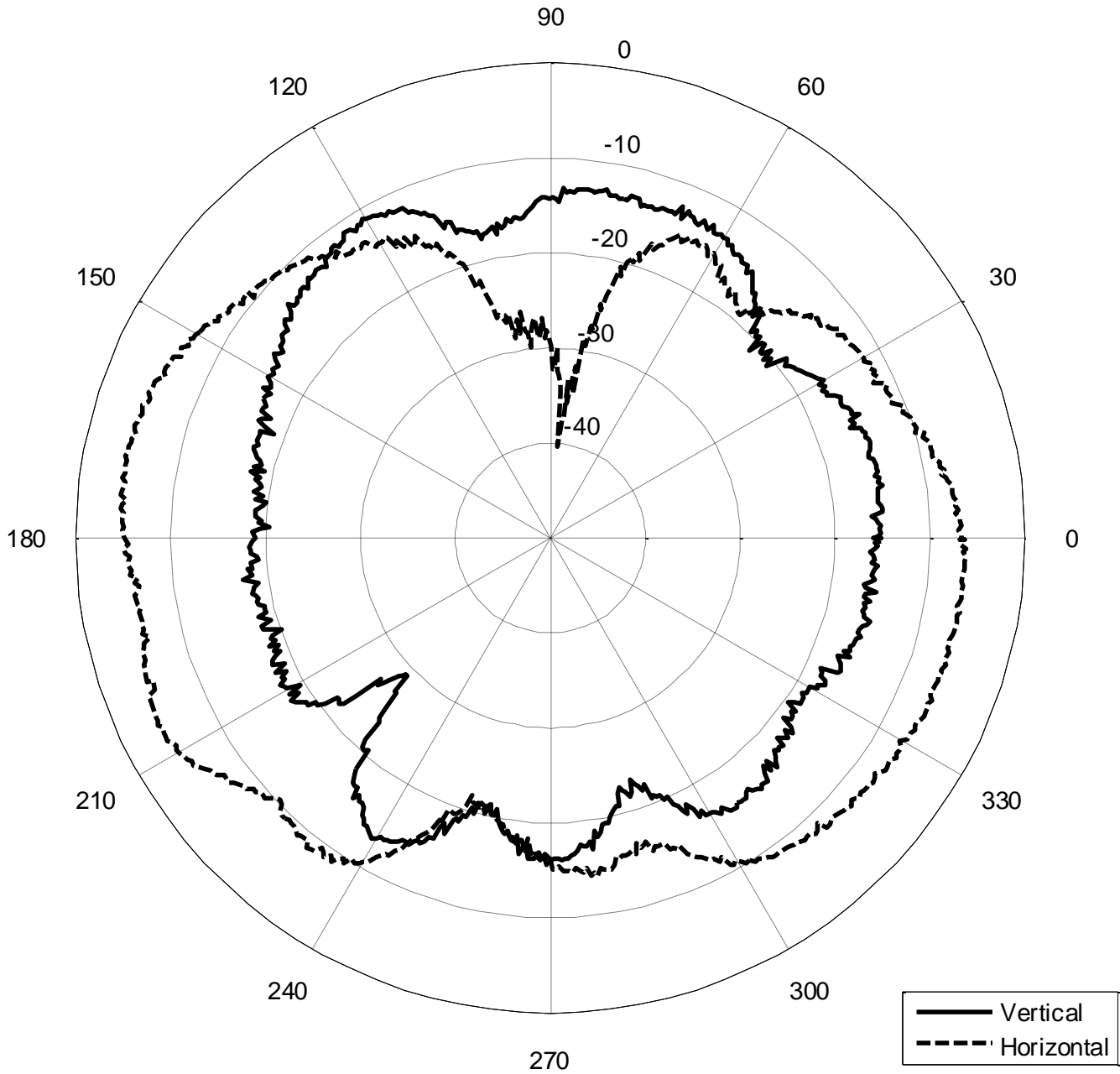

Figure 17 PCB Trace Antenna Pattern (Elevation @ 2480 MHz)

Vertical, Horizontal Antenna Patterns at 2480 MHz (dB) - Second Elevation Cut

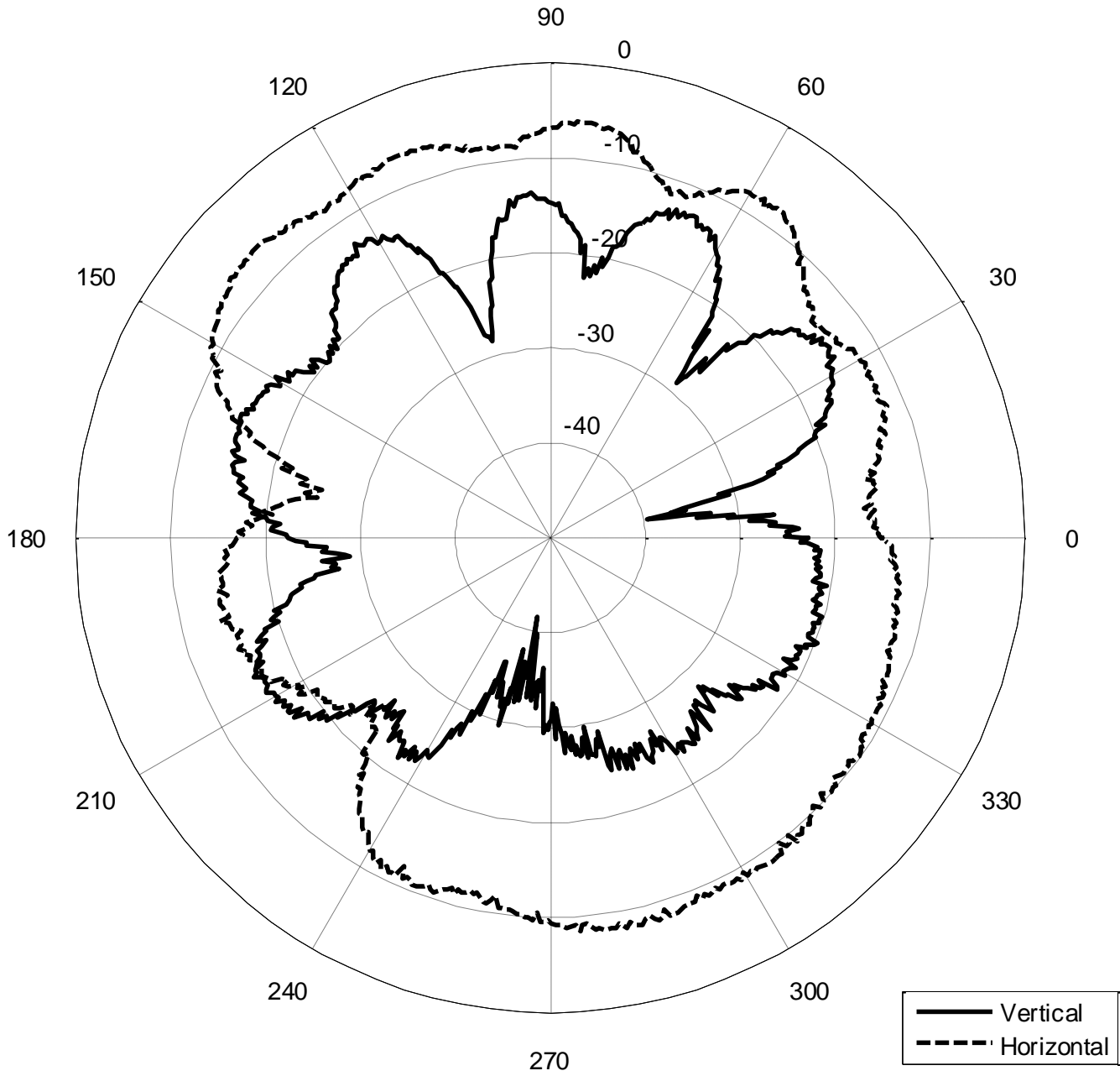

Figure 18 PCB Trace Antenna Pattern (2<sup>nd</sup> Elevation @ 2480 MHz)

MECHANICAL DATA

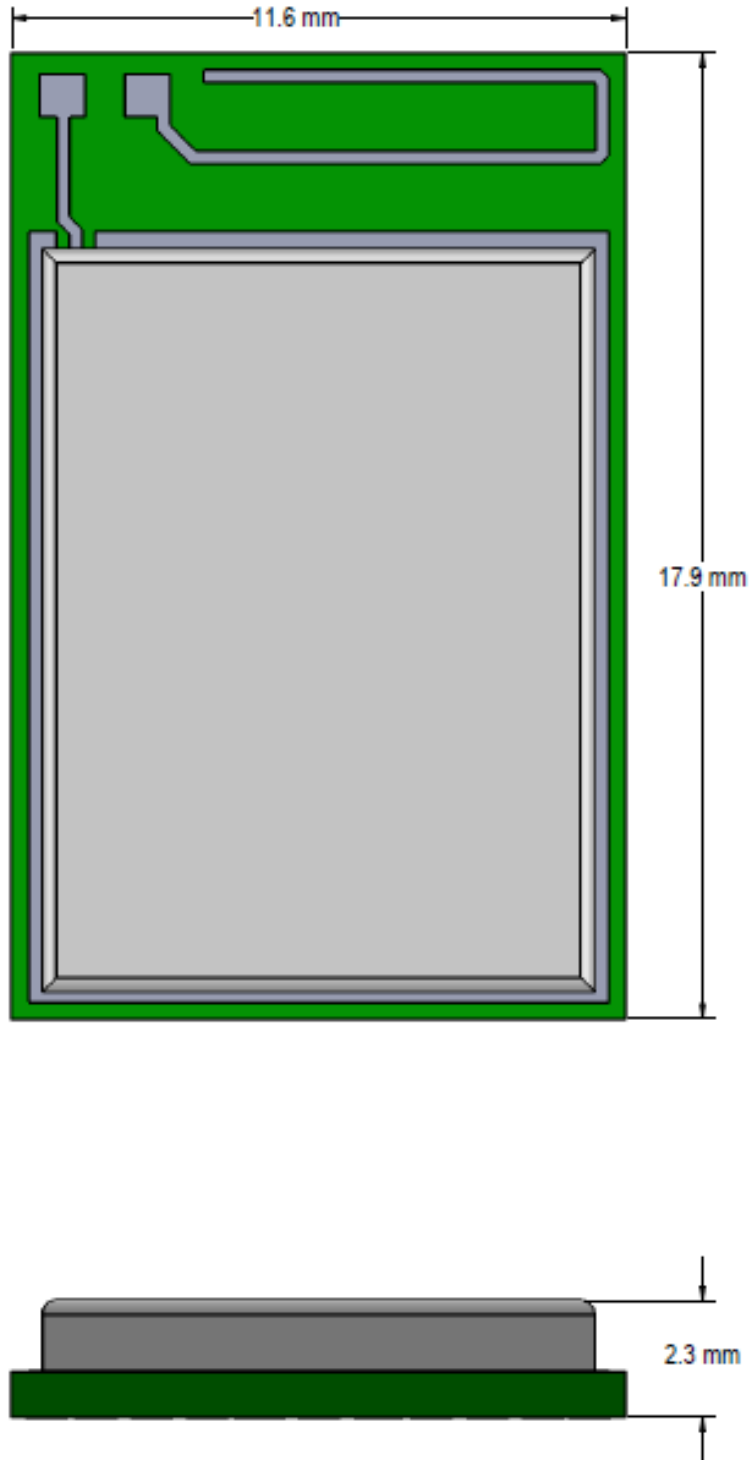
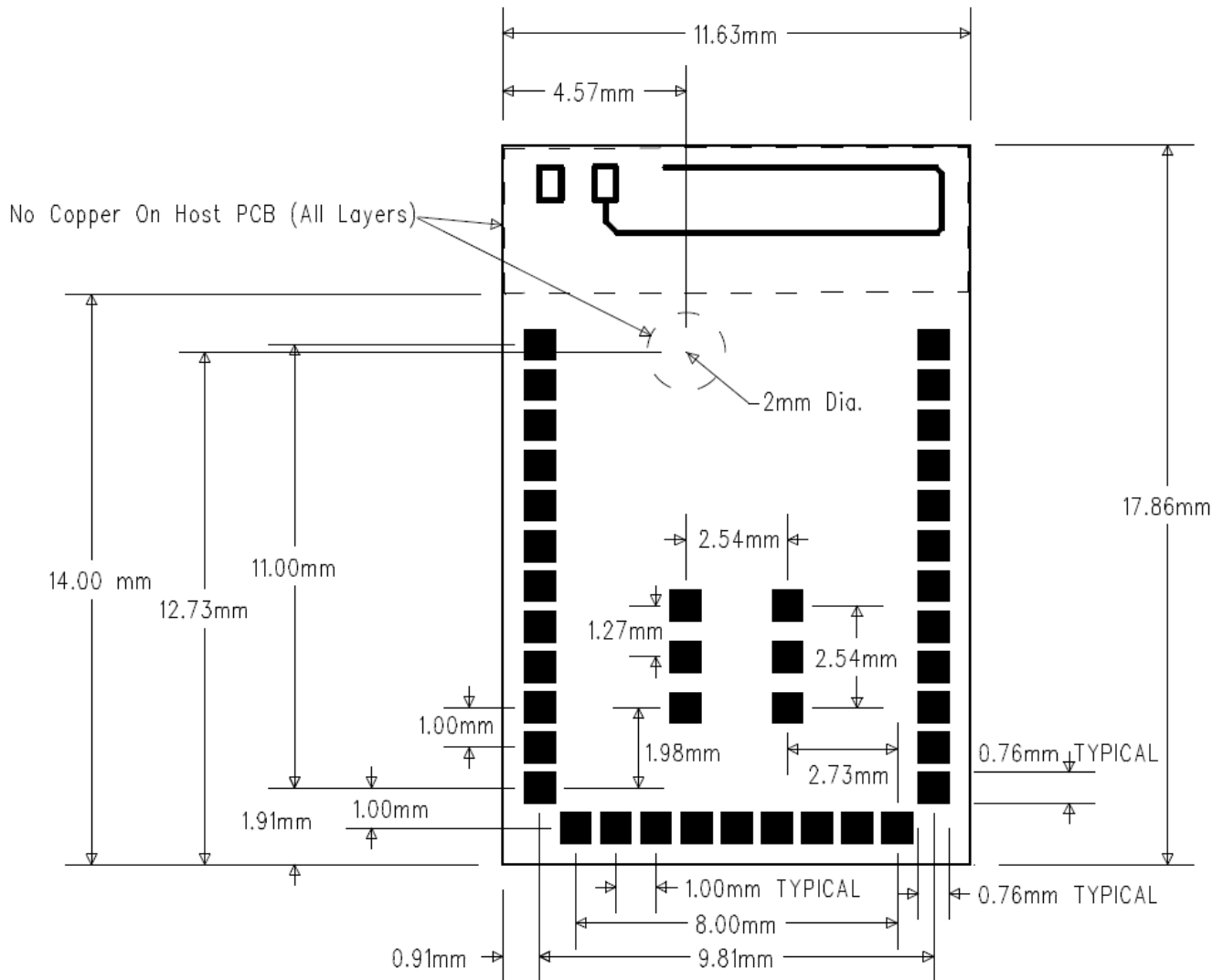

Figure 19 Module Mechanical Dimensions (Maximum Module Height = 2.4mm)

The information in this document is subject to change without notice.

**PCB FOOTPRINT**



**Figure 20 SaBLE-x Recommended PCB Footprint (Viewed from Top)**

The information in this document is subject to change without notice.



---

**DEVICE MARKINGS****Rev 1 Devices**

- Initial release.

LSR Model: SaBLE-x P/N: 450-0119-R1 FCC ID: TFB-1002 IC: 5969A-1002 20C0D00001
---

The shield on the 450-0119 / 450-0144 modules contains the following information:

- LSR Model: SaBLE-x
- Part Number and Revision:
  - Part Number: 450-0119 or 450-0144
  - Revision: -RX (where X is the latest revision)
- FCC ID: TFB-1002
- IC: 5969A-1002
- Manufacturer Information

**Rev 2 Devices**

- Updated component value based on updates to the CC2640 reference design.

LSR Model: SaBLE-x P/N: 450-0119-R2 FCC ID: TFB-1002 IC: 5969A-1002 20C0D00001
---

The shield on the 450-0119 / 450-0144 modules contains the following information:

- LSR Model: SaBLE-x
- Part Number and Revision:
  - Part Number: 450-0119 or 450-0144
  - Revision: -RX (where X is the latest revision)
- FCC ID: TFB-1002
- IC: 5969A-1002
- Manufacturer Information

---

The information in this document is subject to change without notice.



### Rev 3 Devices

- Updated the label to include Giteki and Australia/New Zealand EMC marking information.
- Updated the label to include a date code.

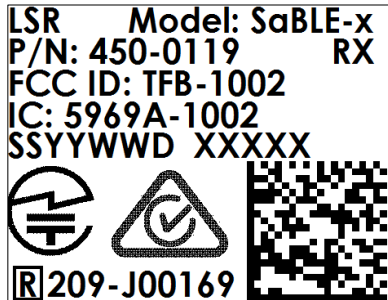

The shield on the 450-0119 / 450-0144 modules contains the following information:

- LSR Model: SaBLE-x
- Part Number and Revision:
  - Part Number: 450-0119 or 450-0144
  - Revision: -RX (where X is the latest revision)
- FCC ID: TFB-1002
- IC: 5969A-1002
- SSYYWWD = Date Code (YY=Year, WW=Week)
- XXXXX = Incremental Serial Number
- 2D Barcode Format is Data Matrix Standard

---

**CONTACTING LSR**

<b>Headquarters</b>	LSR W66 N220 Commerce Court Cedarburg, WI 53012-2636 USA Tel: 1(262) 375-4400 Fax: 1(262) 375-4248
<b>Website</b>	<a href="http://www.lsr.com">www.lsr.com</a>
<b>Technical Support</b>	<a href="http://forum.lsr.com">forum.lsr.com</a>
<b>Sales Contact</b>	<a href="mailto:sales@lsr.com">sales@lsr.com</a>

The information in this document is provided in connection with LS Research (hereafter referred to as “LSR”) products. No license, express or implied, by estoppel or otherwise, to any intellectual property right is granted by this document or in connection with the sale of LSR products. EXCEPT AS SET FORTH IN LSR’S TERMS AND CONDITIONS OF SALE LOCATED ON LSR’S WEB SITE, LSR ASSUMES NO LIABILITY WHATSOEVER AND DISCLAIMS ANY EXPRESS, IMPLIED OR STATUTORY WARRANTY RELATING TO ITS PRODUCTS INCLUDING, BUT NOT LIMITED TO, THE IMPLIED WARRANTY OF MERCHANTABILITY, FITNESS FOR A PARTICULAR PURPOSE, OR NON-INFRINGEMENT. IN NO EVENT SHALL LSR BE LIABLE FOR ANY DIRECT, INDIRECT, CONSEQUENTIAL, PUNITIVE, SPECIAL OR INCIDENTAL DAMAGES (INCLUDING, WITHOUT LIMITATION, DAMAGES FOR LOSS OF PROFITS, BUSINESS INTERRUPTION, OR LOSS OF INFORMATION) ARISING OUT OF THE USE OR INABILITY TO USE THIS DOCUMENT, EVEN IF LSR HAS BEEN ADVISED OF THE POSSIBILITY OF SUCH DAMAGES. LSR makes no representations or warranties with respect to the accuracy or completeness of the contents of this document and reserves the right to make changes to specifications and product descriptions at any time without notice. LSR does not make any commitment to update the information contained herein. Unless specifically provided otherwise, LSR products are not suitable for, and shall not be used in, automotive applications. LSR’s products are not intended, authorized, or warranted for use as components in applications intended to support or sustain life.

---

The information in this document is subject to change without notice.